



# EXT-RSL10- PRODUCT GUIDE

## CONTINUOUS LINE OF LIGHT IN A SMALL RECESSED PROFILE

- Suitable for plasterboard use without effecting its structural integrity
- Slick socket
- Maximum LED strip width:10mm

**ledridge**<sup>®</sup> **slick**  
Bespoke as Standard





# EXT-RSL10- PRODUCT GUIDE

- A** slide cover
- Z<sup>1</sup>** Z flexible mounting plate
- Z<sup>2</sup>** cone Z flexible mounting plate

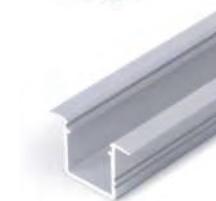
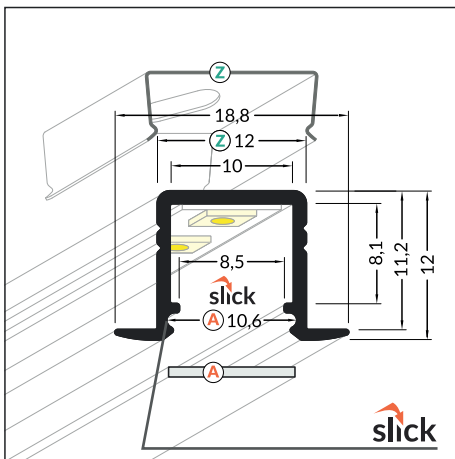
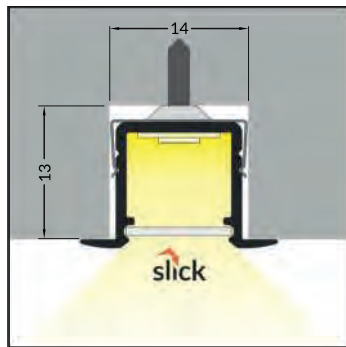
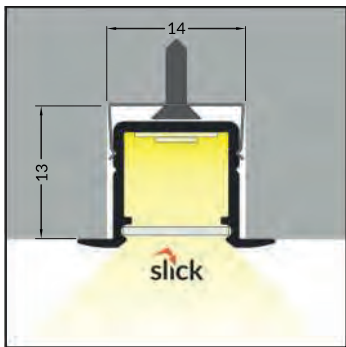
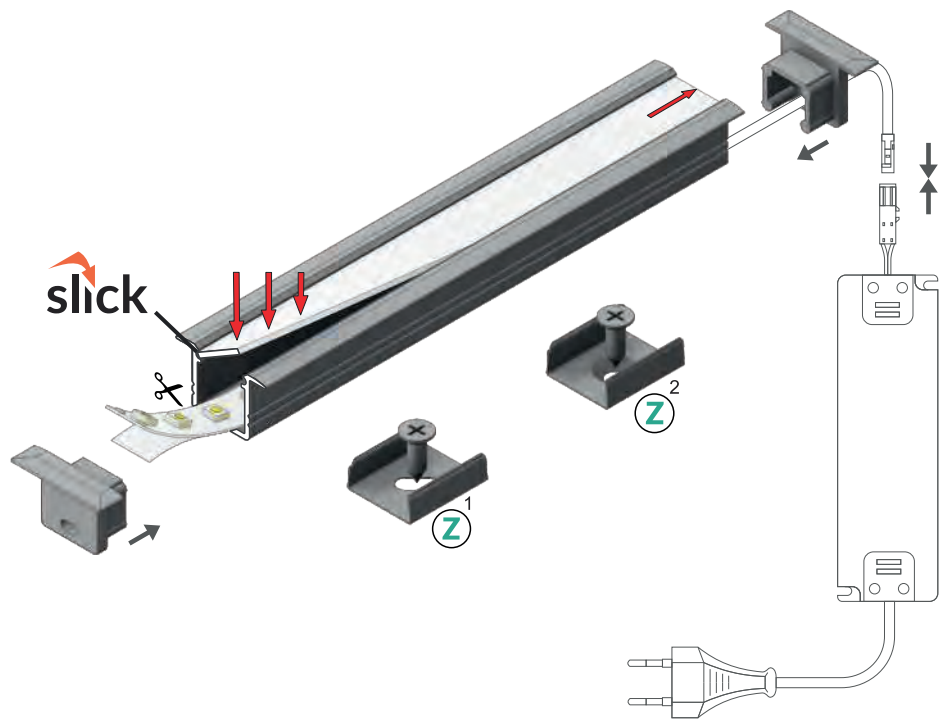

white painted

anodized

black anodized

raw aluminium

max 10 mm

recessed

Available lengths  
1000 mm, 2000 mm



# EXT-RSL10- PRODUCT GUIDE

## COVERS

**A** slide cover  
colours: transparent, frosted, white  
material: PC, PP, PP



**Note!** Dimensions of the space to install LED source

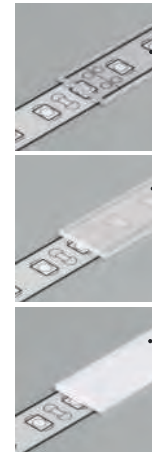
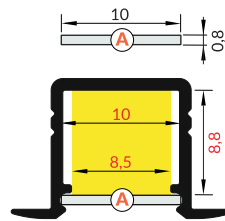

**A** transparent

**A** frosted

**A** white

## END CAPS

colours: white, silver, black, grey  
material: ABS

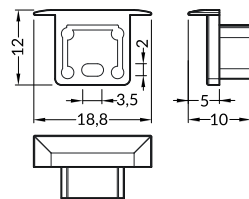

○ white

● silver

● black

● grey

## MOUNTINGS

**Z** flexible mounting plate  
colours: white, black  
material: stainless steel

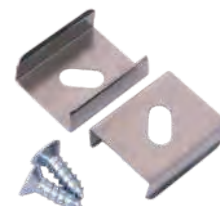
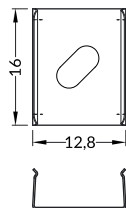
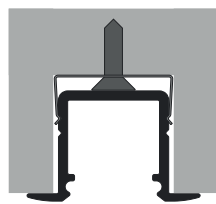

**Z** flexible mounting plate

○ white

● stainless

● black

cone **Z** flexible mounting plate  
colours: white, black  
material: stainless steel

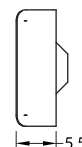
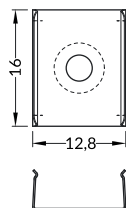
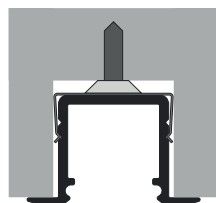

cone **Z** flexible mounting plate

○ white

● stainless

● black



## EXT-RSL10- PRODUCT GUIDE

